



# Panasonic

Integrated Telephone System

Model No. **KX-T2378JXW**

Pulse-or-tone dialing capability

## Operating Instructions



**2 LINE**

**PLEASE READ BEFORE USE AND SAVE.**

*Preparation*

*Basic Operation*

*Advanced Operation*

*Useful Information*

# Before Initial Use

***Thank you for purchasing your new Panasonic integrated telephone.***

## For your future reference

Serial No. \_\_\_\_\_  
(found on the bottom of the unit)

Date of purchase \_\_\_\_\_

Name and address of dealer \_\_\_\_\_

## Accessories (included)

Handset . . . . . one  
(p. 7)

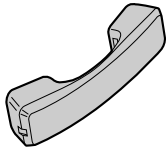

Handset Cord . . . . . one  
(p. 7)

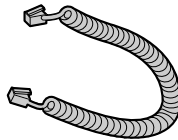

4-Wire Telephone Line Cord  
with Green Plugs . . . . . one  
(p. 8, 9)

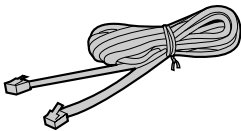

2-Wire Telephone Line Cord  
with Transparent Plugs. . . . . one  
(p. 8, 9)

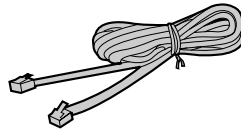

Wall Mounting Adaptor . . . . . one  
(p. 14)

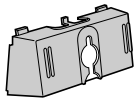

# Contents

## *Preparation*

<b>Location of Controls</b> .....	4
<b>Display</b> .....	6
<b>Settings</b> .....	7
Installing the Batteries .....	7
Connecting the Handset .....	7
Connecting the Telephone Line Cord .....	8
Connecting a Communication Device .....	9
Programming Summary of Preparations .....	10
Selecting the Dialing Mode .....	11
Time Adjustment .....	12
Setting the LCD Contrast .....	13
Selecting the Ringer Volume .....	13
Wall Mounting .....	14

## *Basic Operation*

<b>Making Calls</b> .....	15
<b>Answering Calls</b> .....	17

## *Advanced Operation*

<b>Using the Other Line During a Conversation</b> .....	18
<b>Conference call</b> .....	19
<b>Speed Dialer</b> .....	20
Storing Phone Numbers in Memory .....	20
Dialing a Stored Number .....	21
<b>One-Touch Dialer</b> .....	22
Storing Phone Numbers in Memory .....	22
Dialing a Stored Number .....	24
<b>Special Features</b> .....	25
For Call Waiting Service Users .....	25
Temporary Tone Dialing (For Rotary or Pulse Service Users) .....	25
How to Use the PAUSE Button (For Analog PBX Line/Long Distance Service Users) .....	25
Muting Your Conversation .....	26
FLASH Button .....	26
Setting the PIN Code .....	27
Dial Lock .....	28
Call Restriction .....	29

## *Useful Information*

<b>Using the Optional Headset</b> .....	30
<b>Battery Replacement</b> .....	32
<b>Before Requesting Help</b> .....	33
<b>Safety Instructions</b> .....	35

*Preparation*

*Basic Operation*

*Advanced Operation*

*Useful Information*

# Location of Controls

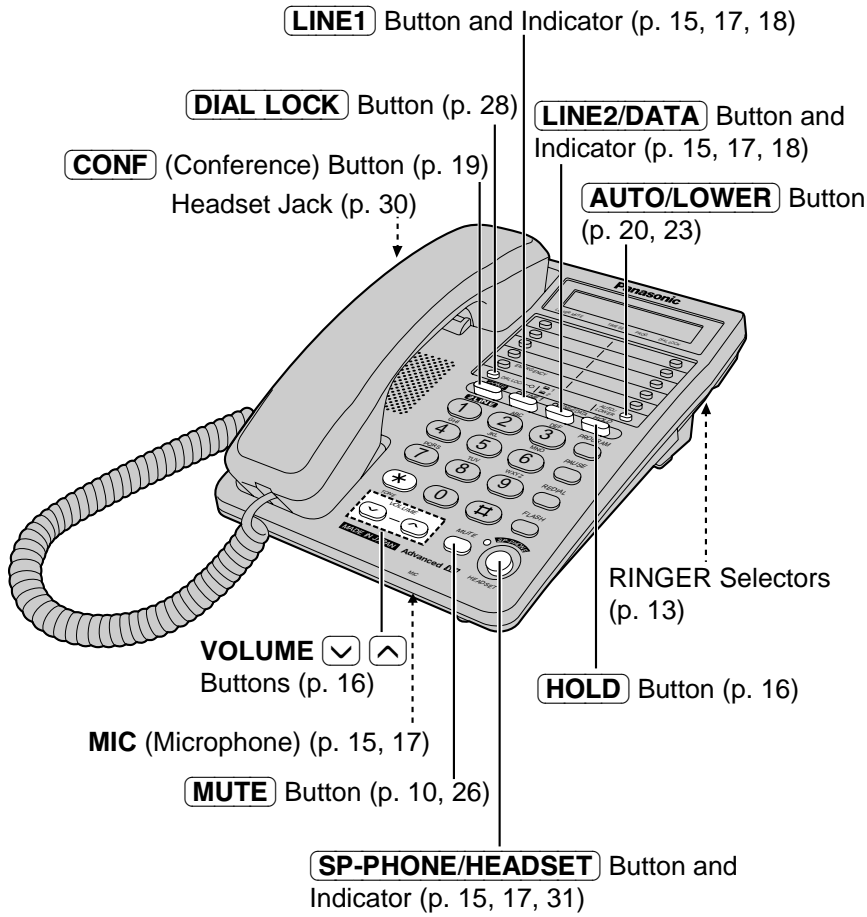

*Preparation*

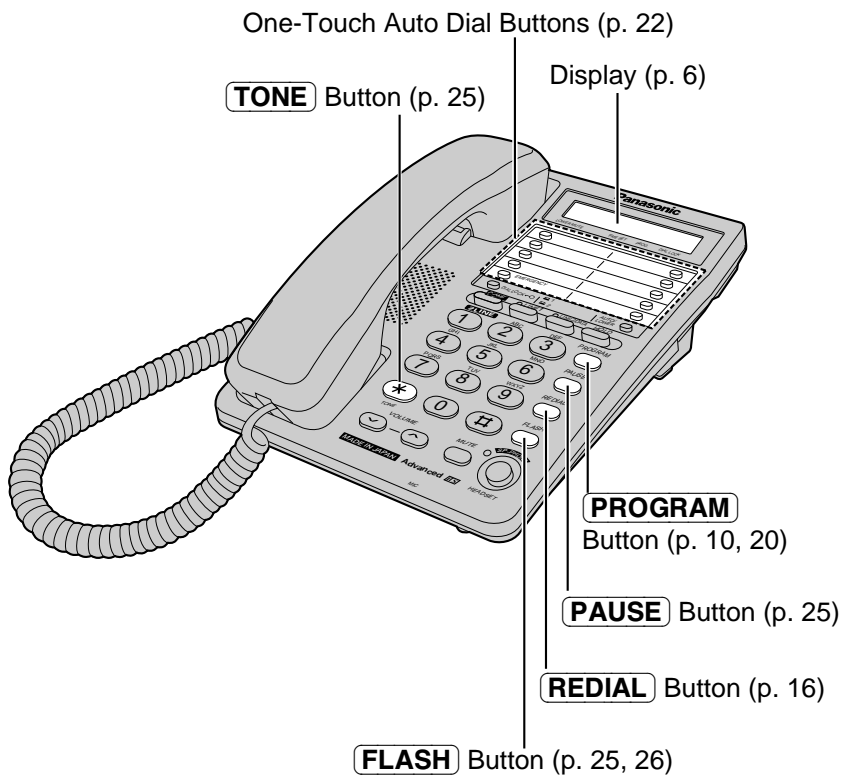

# Display

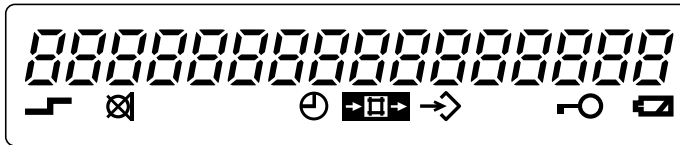

(This display shows all of the possible configurations.)

*12-000* : In the standby mode, the display shows the current time.  
(Ex. 12:00AM)

*02-14-30* : During a conversation, the call duration is displayed.  
(Ex. 2 hours, 14 minutes, 30 seconds)

*F* : **FLASH** was pressed.

*P* : **PAUSE** was pressed while storing phone numbers.

*\** : **\*** was pressed while dialing.

*#* : **#** was pressed while dialing.

: **AUTO/LOWER** was pressed (p. 20, 23).

: **MUTE** was pressed during a conversation (p. 26).

: The unit is in the clock setting mode (p. 12).

: The unit is in the programming mode (p. 10).

: The dial lock mode is set. To cancel the mode, see page 28.

: This display flashes, when the battery power is low. To replace the batteries, see page 32.

# Settings



## Installing the Batteries

- 1 Press down in the direction of the arrow and open the cover.
- 2 Install the batteries in the proper order as shown, matching the correct polarity.
- 3 Close the battery cover.

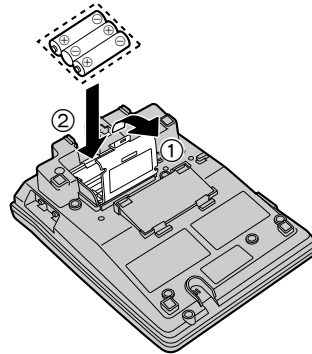

Preparation

- Batteries are not included in the unit.
- Install three high quality "LR6" Alkaline or "R6" Manganese batteries. We recommend to use Alkaline batteries.  
Battery life is: —about six months in use of Alkaline batteries.  
—about three months in use of Manganese batteries.  
Battery life may depend on usage conditions and ambient temperature.
- Make sure to install the batteries for the following features to operate properly:
  - Display (p. 6)
  - Buttons' function when the handset is on the cradle
  - Speakerphone (p. 15, 17)
  - Programming (p. 10)

## Connecting the Handset

Connect the handset as shown below.

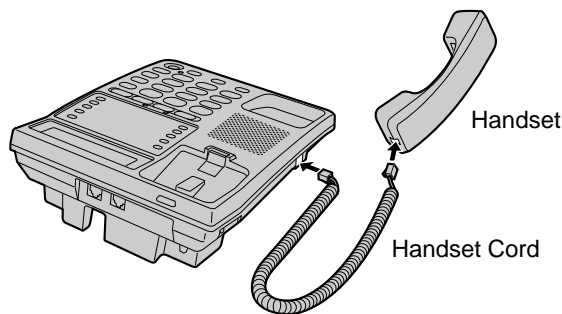

- Use only a Panasonic Handset for the KX-T2378JXW.

## ► Settings

### Connecting the Telephone Line Cord

Connect the telephone line cord(s) to the unit as follows.

#### To connect a two-line telephone jack

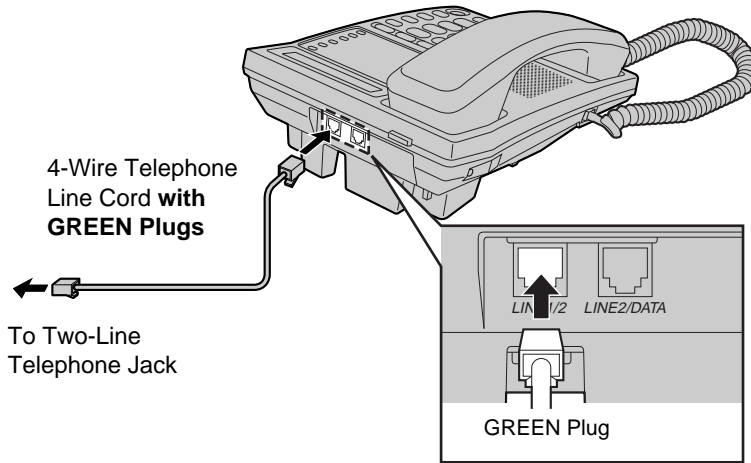

#### To connect two single-line telephone jacks

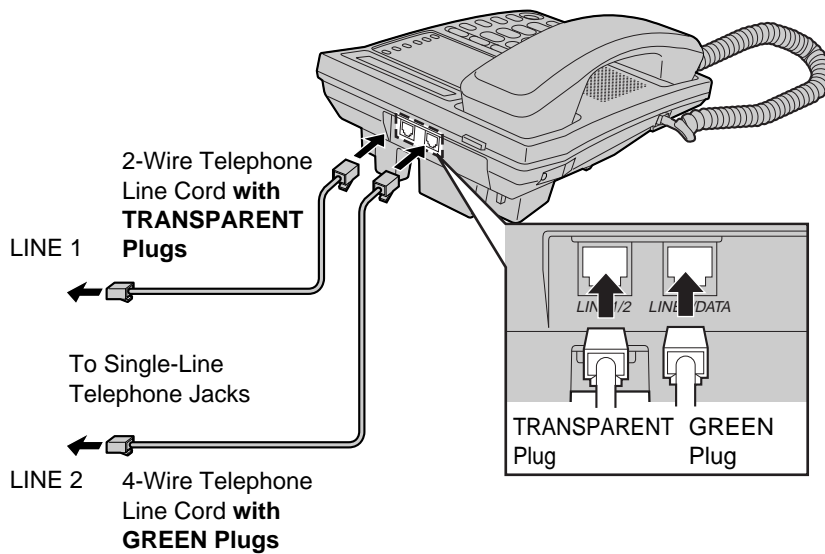





### If you use the unit only as a single-line telephone

Preparation

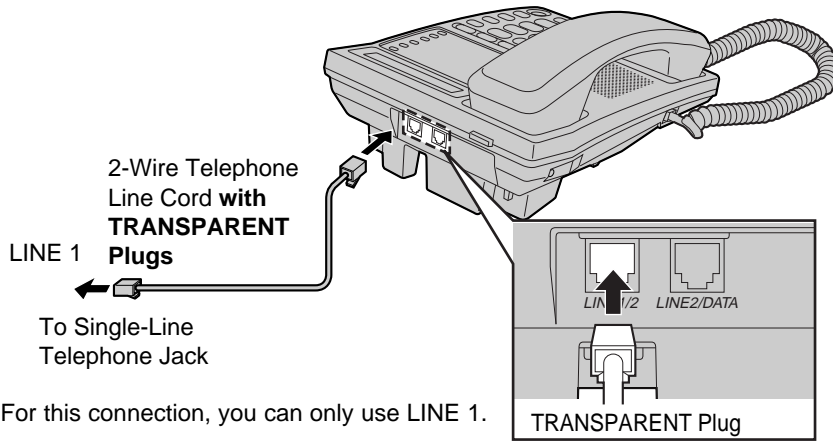

- For this connection, you can only use LINE 1.

### Connecting a Communication Device

After connecting the telephone line cord to a two-line telephone jack, you can connect a communication device (computer, modem, fax, answering machine, etc.) through this unit using the LINE2/DATA jack.

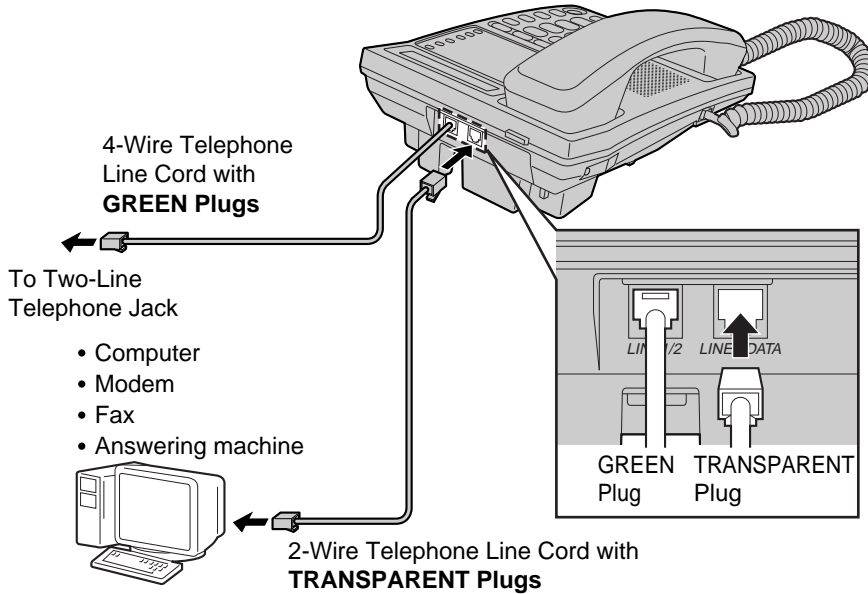

- If the LINE2/DATA indicator lights red, the communication device is in use. Use LINE1 to make or answer other calls. Otherwise the communication device may not operate properly.

## ► Settings

### Programming Summary of Preparations

You can program the following functions. The display shows the programming instructions. See the corresponding pages for function details.

**Make sure that a call is not put on hold.**

Press **PROGRAM**.



Press **MUTE**.



- To set the call restriction, press **1**. (page 29)
- To change the flash time, press **2**. (page 26)
- To select the dialing mode, press **3**. (page 11)
- To change the PIN code for the dial lock and call restriction, press **5**. (page 27)
- To adjust the time, press **6**. (page 12)
- To change the LCD contrast setting, press **7**. (page 13)



Press **PROGRAM** to store the setting.

- You can exit the programming mode any time by pressing **PROGRAM**.
- If you do not press any buttons for 60 seconds, the unit will return to the standby mode.



## Selecting the Dialing Mode

You can select the dialing mode by programming. If you have touch tone service, set to "Tone". If rotary or pulse service is used, set to "Pulse". Your phone comes from the factory set to "Tone".

**Make sure that a call is not put on hold.**

Preparation

**1** Press **PROGRAM**.



**2** Press **MUTE**.



**3** Press **3**.  
•The current setting is displayed.



**4** To select "Pulse", press **2**.  
OR  
To select "Tone", press **1**.







**5** Press **PROGRAM**.  
•A long beep sounds.  
•The unit will return to the standby mode.

## ► Settings

### Time Adjustment

You can select AM/PM or 24-hour clock by programming.

**Make sure that a call is not put on hold.**

- 1 Press **PROGRAM**. 
- 2 Press **MUTE**. 
- 3 Press **6**. 
- 4 Enter the current time (hour and minute) using a 4-digit number. (Ex. To set 9:30, enter "0930".) 
- 5 Press **#** to select AM, PM or 24-hour clock. (Ex. You select PM.) 

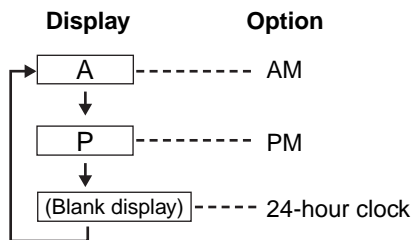

- Each time you press **#**, the selection will change on the display.

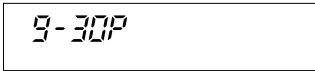
- 6 Press **PROGRAM**. 
  - A long beep sounds.
  - The clock starts working.
  - If an alarm sound is heard when entering the time and pressing **PROGRAM**, the time entered are not correct. Enter the correct time and press **PROGRAM**.
  - The unit will return to the standby mode.

If the batteries installed in the unit have expired, the time will be shown as "12-00" and "🔋" will flash. Readjust the time.





## Setting the LCD Contrast

You can select the LCD contrast level from 1 to 4 by programming. Your phone comes from the factory set to 3.

**Make sure that a call is not put on hold.**

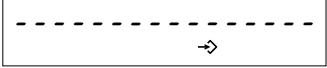
**Preparation**

- 1 Press **PROGRAM**.  

- 2 Press **MUTE**.  

- 3 Press **7**.  
  - The current setting is displayed.
- 4 Press **1** to **4**.  
  - Each time you press a button, the level will change on the display.
- 5 Press **PROGRAM**.  
  - A long beep sounds.
  - The unit will return to the standby mode.

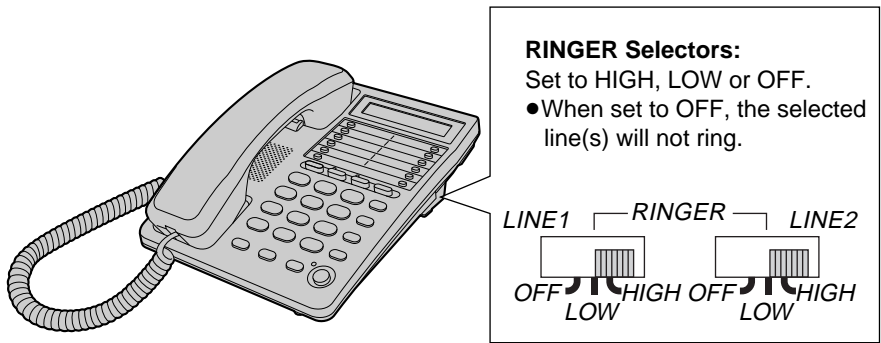
## Selecting the Ringer Volume

You can select the ringer volume of each line to HIGH, LOW or OFF. Your phone comes from the factory set to HIGH.



## ► Settings

### Wall Mounting

This unit can be mounted on a wall.

- 1 Pull down the handset hook until it locks, **so the tab holds the handset.**

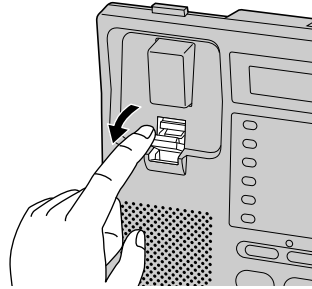

- 2 Tuck the telephone line cord inside the wall mounting adaptor, and push it in the direction of the arrow.
  - “UP” should be facing upward.

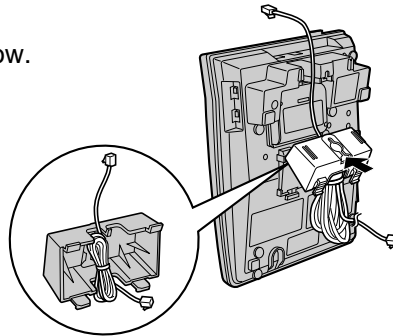

- 3 Install screws using the wall template below. Connect the telephone line cord. Mount the unit, and slide down.

To temporarily set the handset down during a conversation, place it as shown here.

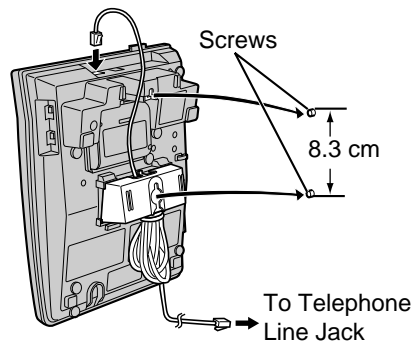
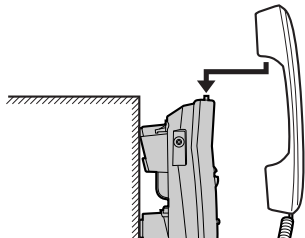

#### Wall Template

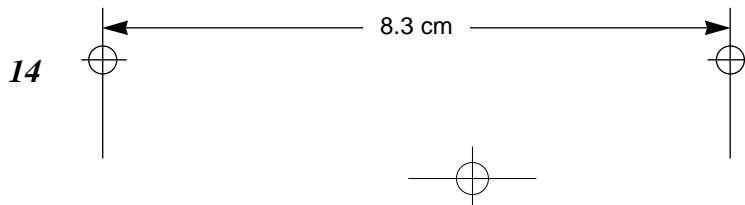

# Making Calls



## Using the handset

- 1 Press **LINE1** or **LINE2/DATA** to select a telephone line.
  - The line indicator lights red.
- 2 Lift the handset.
  - The line indicator lights red.
- 3 Dial a phone number.
  - The dialed number is displayed.
  - After a few seconds, the display will show the length of the call.
  - If you misdial, hang up and start again from step 1.
- 4 To hang up, place the handset on the cradle.
  - The line indicator light goes out.
  - The display will return to the standby mode.

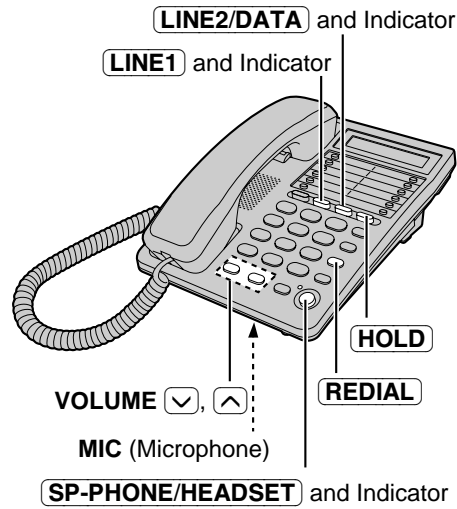

Basic Operation

## Using the speakerphone

- 1 Press **LINE1** or **LINE2/DATA** to select a telephone line.
  - 2 Press **SP-PHONE/HEADSET**.
    - The line indicator lights red and the SP-PHONE/HEADSET indicator lights.
  - 3 Dial a phone number.
    - The dialed number is displayed.
    - After a few seconds, the display will show the length of the call.
    - If you misdial, press **SP-PHONE/HEADSET** and start again from step 1.
  - 4 When the other party answers, talk into the **MIC** (microphone).
  - 5 To hang up, press **SP-PHONE/HEADSET**.
    - The indicator light goes out.
    - The display will return to the standby mode.
- Be sure that the **CONF** (Conference) button is released.
  - If the LINE2/DATA jack is connected to a communication device (p. 9) and the LINE2/DATA indicator lights red, the communication device is in use. Use LINE1 to make or answer other calls. Otherwise the communication device may not operate properly.

## ► Making Calls

### To adjust the handset volume (4 levels) or the speaker volume (8 levels) while talking

To increase, press **VOLUME** . To decrease, press **VOLUME** .

Ex. Handset volume level: 2

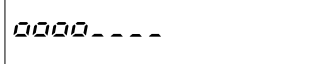

- One level of the handset volume is shown by "00".
- The display shows the volume level for a few seconds.

Ex. Speaker volume level: 3

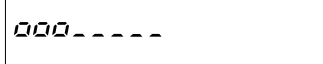

- One level of the speaker volume is shown by "0".
- The display shows the volume level for a few seconds.

### To redial the last number dialed

Press **LINE1** or **LINE2/DATA** →

→ lift the handset or press **SP-PHONE/HEADSET** → press **REDIAL**.

#### Automatic Redial:

When using the speakerphone, the unit redials the last dialed number up to 15 times within a 10-minute period if the line is busy. During redial, the SP-PHONE/HEADSET indicator light flashes.

### To put a call on hold

Press **HOLD**.

- The line indicator lights green.
- If using the handset, you can place it on the cradle.

### To release the hold

Press the line button → lift the handset or press **SP-PHONE/HEADSET**.

- If another phone is connected on the same line, you can also release the hold by lifting its handset.

#### During speakerphone operation

For best performance, please note the following:

- Talk alternately with the other party in a quiet room.
- If the other party has difficulty hearing you, press **VOLUME**  to decrease the speaker volume.
- You can switch to the handset by lifting it up. To switch back to the speakerphone, press **SP-PHONE/HEADSET**.



## What the line indicator means

Off	The line is free.
On (red)	You are using the line or someone else is using the line on a parallel connected telephone.
On (green)	A call is on hold.
Flashing (red)	A call is being received.

## Answering Calls

While a call is being received, the unit rings and the called line indicator flashes red.

### Using the handset

- 1 Press the line button whose indicator is flashing.
- 2 Lift the handset.
  - The line indicator lights red.
- 3 To hang up, place the handset on the cradle.
  - The indicator light goes out.

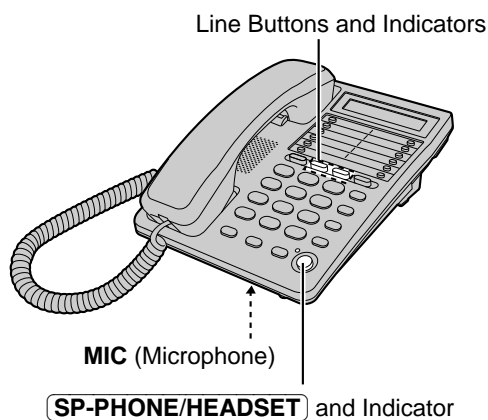

Basic Operation

### Using the speakerphone

- 1 Press the line button whose indicator is flashing.
  - 2 Press **SP-PHONE/HEADSET**.
    - The line indicator lights red and the SP-PHONE/HEADSET indicator light.
  - 3 Talk into the **MIC** (microphone).
  - 4 To hang up, press **SP-PHONE/HEADSET**.
    - The indicator lights go out.
- When the RINGER selector(s) is/are set to OFF (p. 13), the selected line(s) will not ring.
  - Be sure that the **CONF** (Conference) button is released.

## Using the Other Line During a Conversation

During a conversation, if the other line indicator flashes red, an incoming call is being received on the line. You can answer the second call while holding the first call. You can also make a call without terminating the first call.

### Ex: If you are using LINE1

**1** Press **HOLD** to put the first call (LINE1) on hold.

- The LINE1 indicator lights green.
- If you are using the handset, place it on the cradle.

**2** Press the other line button (LINE2/DATA) and either lift the handset or press **SP-PHONE/HEADSET** to make or answer a second call.

- The LINE2/DATA indicator lights red.

**3** To return to the first call (LINE1), press the line button for the first call (LINE1).

- The second call is terminated.

- To hold the second call in step 3, press **HOLD** before pressing the line button for the first call and either lift the handset or press **SP-PHONE/HEADSET**.

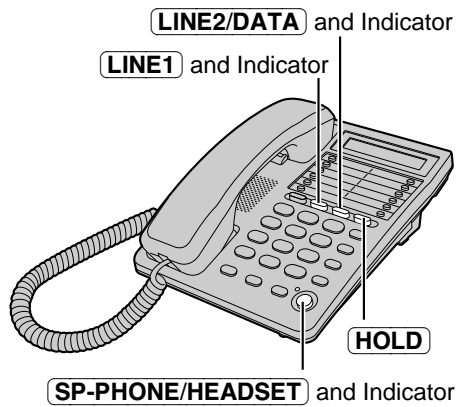

# Conference Call

While having a conversation on one line, you can make or answer a second call on the other line and then combine both calls together to make a conference call.

## Ex: If you are using LINE 1

**1** Press **HOLD** to put the first call (LINE1) on hold.

- The LINE 1 indicator lights green.
- If you are using the handset, place it on the cradle.

**2** Press the other line button (LINE2/DATA) and either lift the handset or press **SP-PHONE/HEADSET** to make or answer a second call.

- The LINE2/DATA indicator lights red.

**3** When the second call is connected, press **CONF** to make a conference call.

- Both line indicators light red.

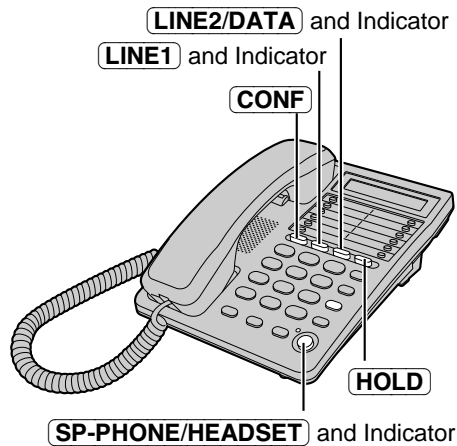

### During a conference call:

- To hang up both lines**, place the handset on the cradle or press **SP-PHONE/HEADSET**. Then press **CONF**.
- To hang up only one line**, press the line button you want to continue talking with, then press **CONF**.

# Speed Dialer

## Storing Phone Numbers in Memory

You can store up to 10 phone numbers in memory. The dialing buttons (0 to 9) function as memory stations. Do not press any memory stations before storing to prevent misoperation.

**Make sure that a call is not put on hold.**

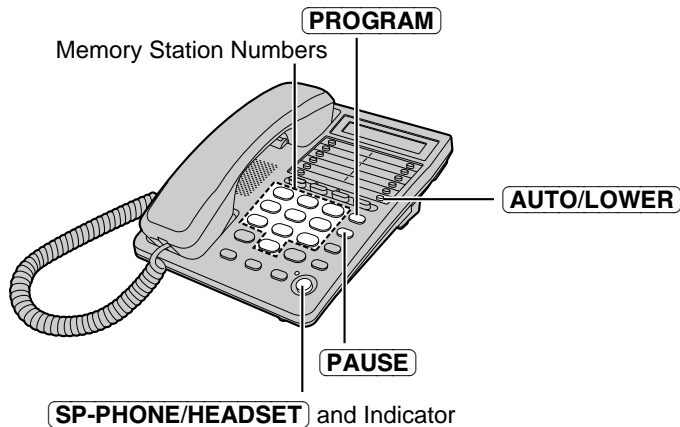

**1** Press **PROGRAM**.

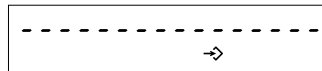

**2** Enter a phone number, up to 22 digits.  
 • If you enter a wrong number, press **PROGRAM** and start again from step 1.

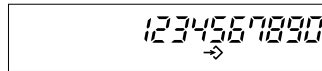

**3** Press **AUTO/LOWER**.

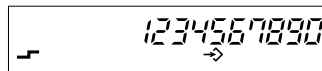

**4** Press a memory station number (0 to 9).

- A long beep sounds.
- The unit will return to the standby mode.
- If 3 beeps sound, the number entered in step 2 may be over 22 digits. Lift the handset and place it on the cradle to return to the standby mode, and start again from step 1.

- You can exit the programming mode in step 1 and 2 by pressing **PROGRAM**.
- If a pause is required for dialing, press **PAUSE** where needed. Pressing **PAUSE** counts as one digit (p. 25).

## To erase a stored number

- 1 Press **PROGRAM**.
- 2 Press **AUTO/LOWER**.
- 3 Press a memory station number (**0** to **9**) for the phone number to be erased.
  - A long beep sounds.
  - The unit will return to the standby mode.

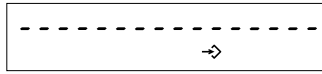

## Dialing a Stored Number

- 1 Press **LINE1** or **LINE2/DATA** to select a telephone line.
- 2 Lift the handset or press **SP-PHONE/HEADSET**.
- 3 Press **AUTO/LOWER**.
- 4 Press the memory station number (**0** to **9**).
  - The stored number is displayed and dialed.

Advanced Operation

# One-Touch Dialer

## Storing Phone Numbers in Memory

You can store up to 20 phone numbers in the one-touch auto dial buttons (10 numbers in UPPER memory locations, 10 numbers in LOWER memory locations).

Do not press any one-touch auto dial buttons before storing to prevent misoperation.

**Make sure that a call is not put on hold.**

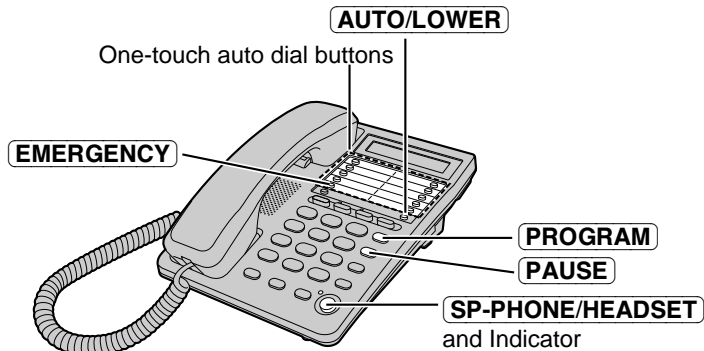

### To store in an UPPER memory location

It is recommended that you program an emergency number in the EMERGENCY button.

**1** Press **PROGRAM**.

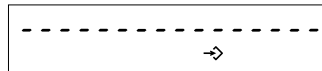

**2** Enter a phone number, up to 22 digits.  
 • If you enter a wrong number, press **PROGRAM** and start again from step 1.

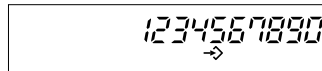

**3** Press one of the one-touch auto dial buttons.

- A long beep sounds.
- The unit will return to the standby mode.
- If 3 beeps sound, the number entered in step 2 may be over 22 digits.

Press **PROGRAM** to return to the standby mode, and start again from step 1.

- If a pause is required for dialing, press **PAUSE** where needed. Pressing **PAUSE** counts as one digit (p. 25).

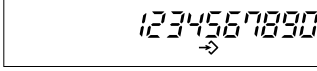
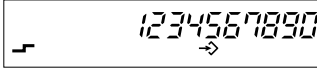

## To store in a LOWER memory location

- 1 Press **PROGRAM**.  

- 2 Enter a phone number, up to 22 digits.  
 • If you enter a wrong number, press **PROGRAM** and start again from step 1.  

- 3 Press **AUTO/LOWER**.  

- 4 Press one of the one-touch auto dial buttons.  
 • A long beep sounds.  
 • The unit will return to the standby mode.  
 • If 3 beeps sound, the number entered in step 2 may be over 22 digits. Lift the handset and place it on the cradle to return to the standby mode, and start again from step 1.  
 • If a pause is required for dialing, press **PAUSE** where needed. Pressing **PAUSE** counts as one digit (p. 25).

## To erase a stored number

- 1 Press **PROGRAM**.  

- 2 If the phone number is in an UPPER memory location, press the one-touch auto dial button for the phone number to be erased.  
 OR  
 If the phone number is in a LOWER memory location, press **AUTO/LOWER**, then press the one-touch auto dial button for the phone number to be erased.  
 • A long beep sounds.  
 • The unit will return to the standby mode.

## ► One-Touch Dialer

### Dialing a Stored Number

#### From an UPPER memory location:

- 1 Press **LINE1** or **LINE2/DATA** to select a telephone line.
- 2 Lift the handset or press **SP-PHONE/HEADSET**.
- 3 Press the required one-touch auto dial button.
  - The stored number is displayed and dialed.

OR

#### From a LOWER memory location:

- 1 Press **LINE1** or **LINE2/DATA** to select a telephone line.
- 2 Lift the handset or press **SP-PHONE/HEADSET**.
- 3 Press **AUTO/LOWER**.
- 4 Press the required one-touch auto dial button.
  - The stored number is displayed and dialed.

### Memory card

Remove the memory card and use it as a name or phone number index for the stored numbers.

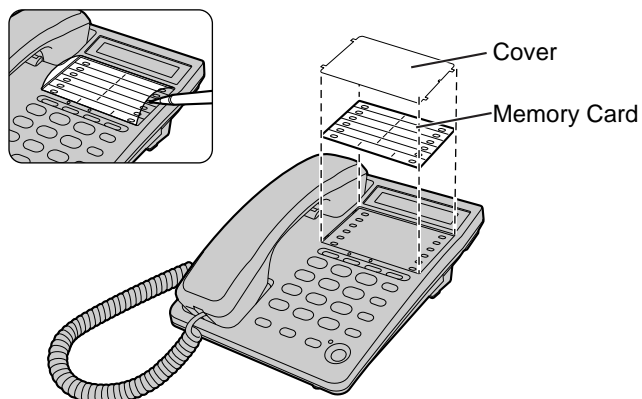



# Special Features

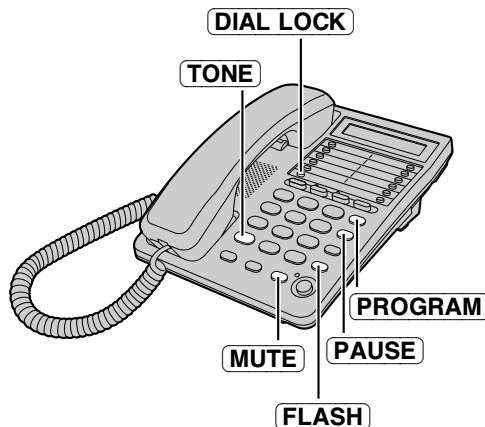

## For Call Waiting Service Users

Press **FLASH** if you hear a call-waiting tone while talking.

- The first call is put on hold and you can answer the second call.
- “*F*” is displayed.
- To return to the first caller, press **FLASH** again.
- If this function does not operate properly, consult your telephone company.

## Temporary Tone Dialing (For Rotary or Pulse Service Users)

Press **TONE** before entering access numbers which require tone dialing.

- “*T*” is displayed.
- The dialing mode changes to tone. You can enter numbers to access an answering service, electronic banking service, etc. When you hang up, the mode will return to pulse.

## How to Use the PAUSE Button (For Analog PBX Line/Long Distance Service Users)

We recommend you press **PAUSE** if a pause is required for dialing with a PBX or to access a long distance service.

Ex. Line access number **9** (PBX)

**9** → **PAUSE** → Phone number

- Pressing **PAUSE** once creates a few seconds pause. This prevents misdialing when you redial or dial a stored number.
- Pressing **PAUSE** more than once increases the length of the pause between numbers.

## ► Special Features

### Muting Your Conversation

Press **MUTE** while talking.

- “” is displayed.
- The other party cannot hear you but you can hear them.
- To resume the conversation, press **MUTE** again.

### FLASH Button

Pressing **FLASH** allows you to use special features of your host PBX such as transferring an extension call or accessing special telephone services (optional) such as call waiting.

#### Selecting the flash time

The flash time depends on your telephone exchange or host PBX. You can select the following flash times: “80, 90, 100, 110, 200, 250, 300, 400, 600, 700 ms (milliseconds)”. Your phone comes from the factory set to “600 ms”.

**Make sure that a call is not put on hold.**

**1** Press **PROGRAM**.

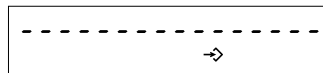

**2** Press **MUTE**.



**3** Press **2**.

- The current setting is displayed.



**4** Press a dialing button (**1** to **0**).

- |                   |                   |                   |                   |
|-------------------|-------------------|-------------------|-------------------|
| <b>1</b> : 80 ms  | <b>2</b> : 90 ms  | <b>3</b> : 100 ms | <b>4</b> : 110 ms |
| <b>5</b> : 200 ms | <b>6</b> : 250 ms | <b>7</b> : 300 ms | <b>8</b> : 400 ms |
| <b>9</b> : 600 ms | <b>0</b> : 700 ms |                   |                   |

**5** Press **PROGRAM**.

- A long beep sounds.
- The unit will return to the standby mode.







- If you are connected via a PBX, a longer flash time may be necessary to use PBX functions (transferring a call, etc.). Consult your PBX installer for the correct setting.



## Setting the PIN Code

A 4-digit PIN Code (Personal Identification Number) prevents unauthorized persons from using your unit. The PIN Code is required for the dial lock and call restriction to be set or canceled. The factory preset PIN code is "1111".

**Make sure that a call is not put on hold.**

- 1 Press **PROGRAM**. 
- 2 Press **MUTE**. 
- 3 Press **5**. 
- 4 Enter the current PIN code.  
(Ex. "1111" is entered.) 
- 5 Press **PROGRAM**.
  - If a correct PIN code is entered, a beep will sound.
  - If a wrong PIN code is entered, 3 beeps will sound. Enter the correct PIN code and press **PROGRAM**.
  - To return to the standby mode, lift the handset and hang up.
- 6 Enter a new PIN code using a 4-digit number.  
(Ex. "1234" is entered.) 
- 7 Press **PROGRAM**.
  - A long beep sounds.
  - The unit will return to the standby mode.

Advanced Operation

Please write down your PIN code. If you forget your PIN code, consult your nearest Panasonic service center.

## ► Special Features

### Dial Lock

You can prevent others from making a call to any number except the one pre-programmed in the memory of the EMERGENCY button. Once you locked the dialing buttons, even emergency numbers cannot be dialed. Only incoming calls are accepted until the dial lock is canceled.

Before using this feature, we recommend storing an emergency number in the memory of the EMERGENCY button (p. 22). Even if the dialing buttons are locked, the number stored in the button can be dialed.

- If you choose not to program emergency numbers, but plan to use the dial lock, any number programmed into the EMERGENCY button can be accessed.

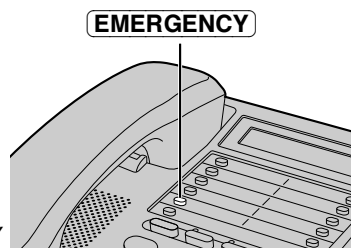

#### To set the dial lock

- 1** Press **DIAL LOCK**.
- "Ⓜ" flashes on the display.



- 2** Enter the PIN code (p. 27).

- 3** Press **PROGRAM**.
- "Ⓜ" is displayed.
  - A long beep sounds.
  - If a wrong PIN code is entered, 3 beeps will sound. Enter a correct PIN code and press **PROGRAM**.
  - The unit will return to the standby mode.

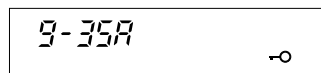

You can use the following features while the dialing buttons are locked.

- Dialing a number you programmed into the memory of the EMERGENCY button (p. 24)
- Adjusting the handset and speakerphone volumes (p. 16)
- Muting the conversation (p. 26)
- Answering the second call by pressing **FLASH** (p. 25)

#### To cancel the dial lock

Follow steps 1 through 3 above again.

- "Ⓜ" will disappear, and the unit will return to the standby mode.









## Call Restriction

You can prevent the unit from dialing phone numbers beginning with specified digit(s) (1 digit or 2 digits). Phone numbers with the restricted leading digits cannot be dialed out.

### To set the call restriction

Make sure that a call is not put on hold.

- 1 Press **PROGRAM**.  

- 2 Press **MUTE**.  

- 3 Press **1**.  
  - If you use "1111" as a PIN code (factory set), the display on the right will be shown. There is no need to enter a PIN code. Go to step 6.
  - After the PIN code is changed, "----" will be displayed.
- 4 Enter the PIN code (p. 27).  
(Ex. Your PIN code is "1234".)  

- 5 Press **PROGRAM**.  
  - If a wrong PIN code is entered, 3 beeps will sound. Enter a correct PIN code and press **PROGRAM**.
  - The current setting is displayed. (Ex. "67" is entered as the restricted digits.)
- 6 Enter the number(s) (1 digit or 2 digits) you want to restrict (**0** to **9**). (Ex. "12" is entered as the restricted digits.)  
  - If you enter a wrong number, enter a correct number.
  - To change restricted digits from 2 digits to 1 digit, press **\*** for 2 digits to change to "--" and enter 1 digit.
- 7 Press **PROGRAM**.  
  - A long beep sounds.
  - The unit will return to the standby mode.

- If your unit is connected to a PBX, this function may not operate. Contact your PBX supplier for more information.

When dialing a phone number with the restricted leading digit(s), the dialed number will flash on the display, but not dialed out.

## ► Special Features

### To cancel the call restriction

Follow steps 1 through 5 on page 29. In step 6 on page 29, press **\*** to cancel call restriction (“- -” is displayed) and press **PROGRAM**.

- A long beep will sound and the unit will return to the standby mode.

## Using the Optional Headset

Plugging the optional headset into the unit allows a hands-free phone conversation. Please use only a Panasonic KX-TCA89BX.

### Connecting the Optional Headset to the Unit

Connect the optional headset to the headset jack as shown below.

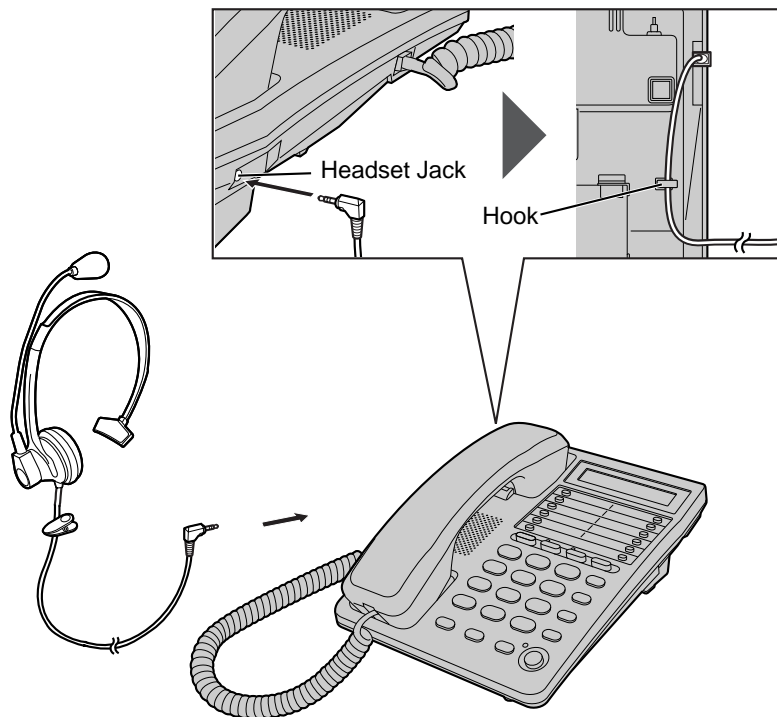

If you want to have a normal conversation, disconnect the headset.

## Making/Answering Calls

Make sure to install the batteries.

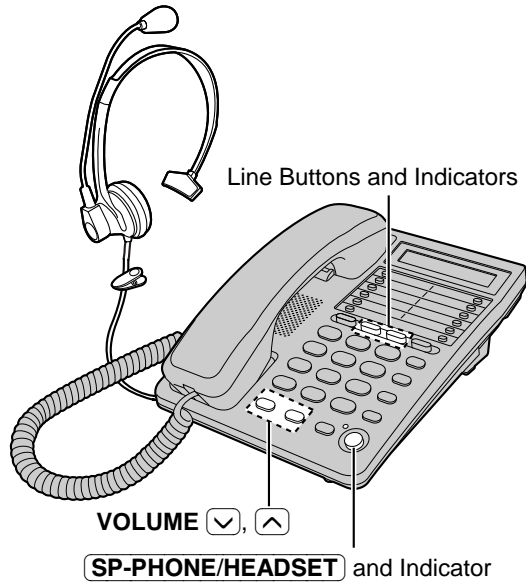

- 1 Press the line button to select the telephone line.
- 2 Press **SP-PHONE/HEADSET** to make or answer a call.
  - The line indicator lights red and SP-PHONE/HEADSET indicator flashes.
  - If you misdial when making a call, press **SP-PHONE/HEADSET** twice and dial again.
- 3 To hang up, press **SP-PHONE/HEADSET**.
  - The indicator light goes out.

### To adjust the headset receiver volume (4 levels):

While using the headset, press **VOLUME** or .

- Be sure that the **CONF** button is released.
- During a conversation using the headset, you cannot switch the call to the handset by lifting it off the cradle.
- If you disconnect the optional headset during a conversation with the handset on the cradle, the call will be switched to the speakerphone.
- During a conversation using the speakerphone, you can switch the call to the headset by connecting the headset.

# Battery Replacement

If “” flashes, the battery power is low. Install new batteries. Replace the batteries within 1 minute to keep the programmed settings. But the programmed time setting will be cleared.

**1** Disconnect the telephone line cord from the unit.

**2** Press down in the direction of the arrow and open the cover.

**3** Replace the batteries with new ones using correct polarity (+, -), and close the cover.

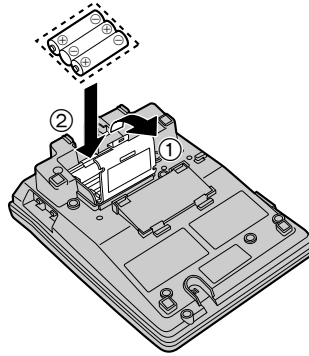

**4** Connect the telephone line cord to the unit.

• If the time is shown as “12-00” and “” flashes after replacing the batteries, readjust the time.

## Battery Precautions:

The batteries should be used correctly, otherwise the unit may be damaged by battery leakage.

- Do not mix different types of batteries.
- Do not charge, short-circuit, disassemble, heat or dispose of in fire.
- Remove all the batteries when replacing.

## Note:

- If you do not install the batteries or if the battery power is low, the time will be shown as “12-00” and “” will flash. Readjust the time.
- Replace all the batteries once a half year in use of Alkaline batteries, or misoperation may occur. (When you use Manganese batteries, replace all of them once in three months.)
- Do not use nickel-cadmium batteries.



## Before Requesting Help

Problem	Remedy
The unit does not work.	<ul style="list-style-type: none"> <li>● Check the settings (p. 7–14).</li> <li>● Remove the batteries and reinstall them to reset the unit.</li> </ul>
The unit does not ring.	<ul style="list-style-type: none"> <li>● The RINGER selector(s) is/are set to OFF. Set to HIGH or LOW (p. 13).</li> </ul>
The line indicators do not work properly.	<ul style="list-style-type: none"> <li>● Check the settings (p. 7–14).</li> <li>● The batteries have become weak. Replace them with new ones (p. 32).</li> </ul>
You cannot dial.	<ul style="list-style-type: none"> <li>● Check that the dialing mode selection is correct (p. 11).</li> <li>● Dial lock mode is set. To cancel the mode, see page 28.</li> <li>● The dialed number is restricted. To cancel, see page 30.</li> </ul>
The other party suddenly cannot hear your voice during a conversation.	<ul style="list-style-type: none"> <li>● <b>MUTE</b> may have been pressed during the conversation. If “” is displayed, press <b>MUTE</b>.</li> </ul>
You cannot program items such as the dialing mode.	<ul style="list-style-type: none"> <li>● Programming is not possible when a call is put on hold.</li> <li>● Do not pause for over 60 seconds while programming.</li> </ul>
You cannot store a phone number in memory.	<ul style="list-style-type: none"> <li>● Confirm the line button is pressed.</li> <li>● Programming is not possible when a call is put on hold.</li> <li>● Check that the batteries are installed in the unit and that the battery power is not low.</li> <li>● Do not enter a phone number more than 22 digits long.</li> </ul>
While programming, the unit starts to ring and stops the program.	<ul style="list-style-type: none"> <li>● To answer the call, lift the handset or press <b>SP-PHONE/HEADSET</b>. Start again from the beginning after hanging up.</li> </ul>
You cannot redial by pressing <b>REDIAL</b> .	<ul style="list-style-type: none"> <li>● If the last number dialed was more than 32 digits long, the number will not be redialed correctly.</li> </ul>

## ► Before Requesting Help

---

Problem	Remedy
Previously programmed information is erased.	<ul style="list-style-type: none"><li>● If the batteries installed in the unit expire, programmed information may be erased. Reprogram if necessary.</li></ul>

# Safety Instructions

Take special care to follow the safety suggestions listed below.

## Installations

### Environment

- 1) Do not use this unit near water—for example, near a bathtub, washbowl, sink, etc. Damp basements should also be avoided.
- 2) The unit should be kept away from heat sources such as radiators, kitchen range, etc. It also should not be placed in rooms where the temperature is less than 5°C or greater than 40°C.

### Placement

- 1) Do not place heavy objects on top of this unit.
- 2) Care should be taken so that objects do not fall onto, and liquids are not spilled into, the unit. Do not subject this unit to excessive smoke, dust, mechanical vibration or shock.
- 3) Place the unit on a flat surface.

### CAUTION:

To reduce the risk of fire or injury to persons, read and follow these instructions.

1. Use only the battery(ies) specified.
2. Do not dispose of the battery(ies) in a fire. It (they) may explode.
3. Do not open or mutilate the battery(ies). Released electrolyte is corrosive and may cause burns or injury to the eyes or skin. The electrolyte may be toxic if swallowed.
4. Exercise care in handling the battery(ies) in order not to short the battery(ies) to conductive materials such as rings, bracelets, and keys. The battery(ies) and/or conductor may overheat and cause burns.
5. Do not recharge the battery(ies) provided with or identified for use with this product. The battery(ies) may leak corrosive electrolyte or explode.
6. Do not attempt to rejuvenate the battery(ies) provided with or identified for use with this product by heating. Sudden release of battery electrolyte may occur causing burns or irritation to the eyes or skin.
7. Replace all batteries at the same time. Mixing fresh and discharged batteries could increase internal cell pressure and rupture the discharged batteries. (Applies to products employing more than one separately replaceable primary battery.)
8. When installing batteries observe the proper polarity or direction. Incorrect installation can cause charging, and may result in leakage or explosion. (Applies to products employing more than one separately replaceable primary battery.)
9. Remove the battery(ies) from this product if the product will not be used for a long period of time (several months or more). During this time the battery(ies) could leak in the product.
10. Discard the “dead” battery(ies) as soon as possible. The “dead” battery(ies) may leak in the product.
11. Do not store this product, or the battery(ies) provided with or identified for use with this product, in high temperature areas. Batteries that are stored in a freezer or refrigerator for the purpose of extending shelf life should be protected from condensation during storage and defrosting. Batteries should be stabilized at room temperature prior to use after cold storage.



**WARNING:**

TO PREVENT FIRE OR SHOCK HAZARD, DO NOT EXPOSE THIS PRODUCT TO RAIN OR ANY TYPE OF MOISTURE.

If there is any trouble, disconnect the unit from the telephone line and connect a known working phone. If the known working phone operates properly, do not reconnect the unit to the telephone line until the trouble has been repaired. If the known working phone does not operate properly, consult your telephone company.

**Kyushu Matsushita Electric Co., Ltd.**

1-62, 4-chome, Minoshima, Hakata-ku, Fukuoka 812-8531, Japan

**PQQX13204YA** F1001-1111 ©

